

OPERATION MANUAL

PEN TYPE ORP METER



Model: ■ 8552, ORP Pen

INTRODUCTION

Congratulations on your purchase of this pen type ORP meter. Please read the manual completely before using this meter. Filing and keeping the manual for future reference. Recommended to soak the electrode for at least 30 min. before using to clear up the lazy effect or to make the ORP electrode wet .

Features:

- **IP65 Waterproof** housing.
- **Big display** for easy reading
- **Data hold** to freeze readings.
- **Pen size**, easy to fit in pocket.
- **Low battery** indicator.
- **Auto power off**.
- Power by 4pcs **LR44** batteries.

MATERIAL SUPPLIED

This package contains:

- ✓ The meter x 1
- ✓ LR44 button battery x 4
- ✓ Operation manual
- ✓ Color box or plain box

POWER SUPPLY

The meter is powered by 4 pcs LR44 batteries. To check the battery when:

1. First time use
2. The battery symbol appears on LCD
3. The meter can not power on

To install the batteries:

1. Turn off the meter.
2. Loosen the battery cover in counter-clockwise direction. (DON'T discard the black washer!)
3. Replace the old batteries with four new button cells LR44.
4. Make sure the batteries are in place and the polarity is correct.
5. Put back the battery cover & washer and turn it tightly in clockwise direction.

NOTE:

- 1. Remove battery from instruments that you do not plan to use for a month or more. Do not leave battery in instrument.**

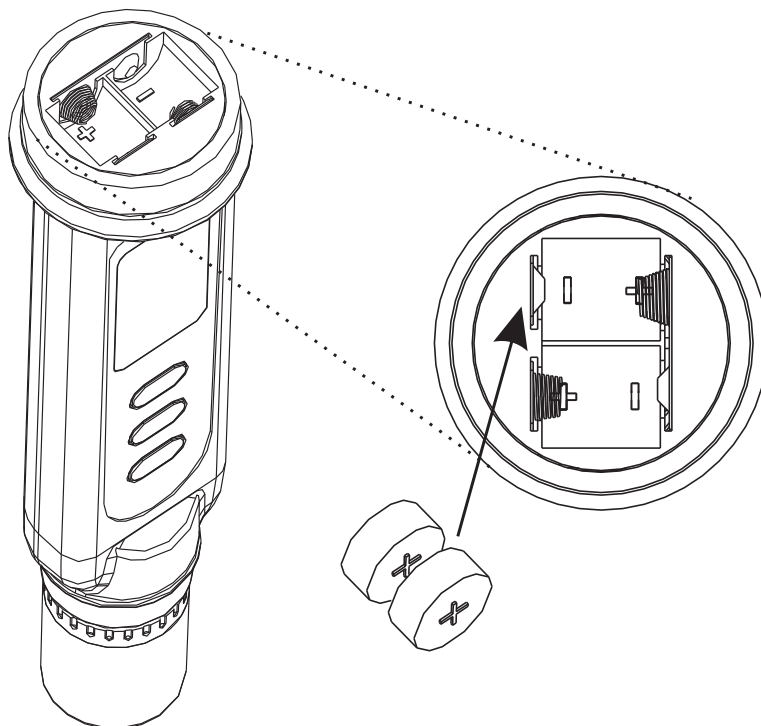

LCD DISPLAY

8552

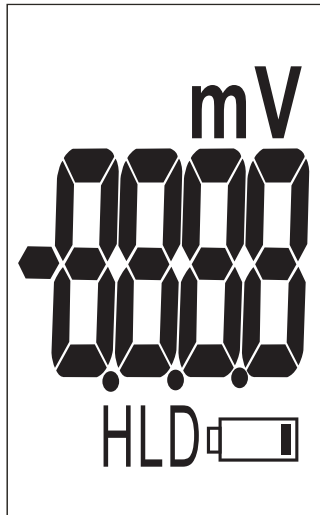

-The main display shows the measured ORP reading.

-Hold=Data hold

KEYPAD

8552



OPERATION

1. Remove the probe cover from meter to expose the electrode out. It is normal if you find white crystals are present on the cap or electrode assembly.

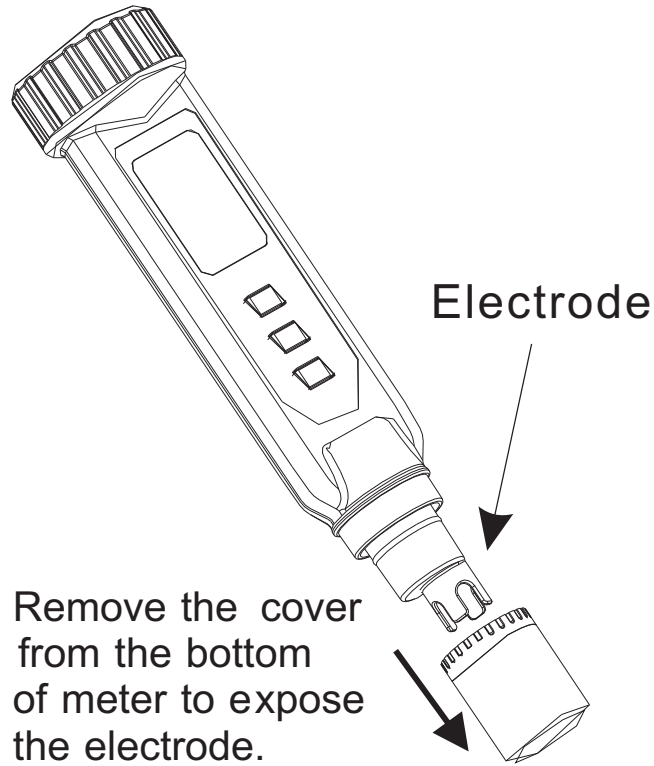

WARNING: For ORP meters, please always make the sponge wet to keep the electrode in a good storage condition.



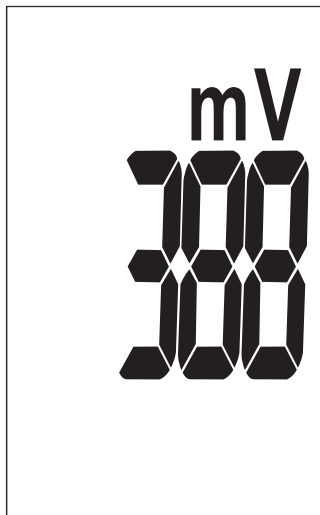

2. Dip the electrode into the test solution. Press " Ⓢ " to power on the meter and stir it to get a stable reading.

8552

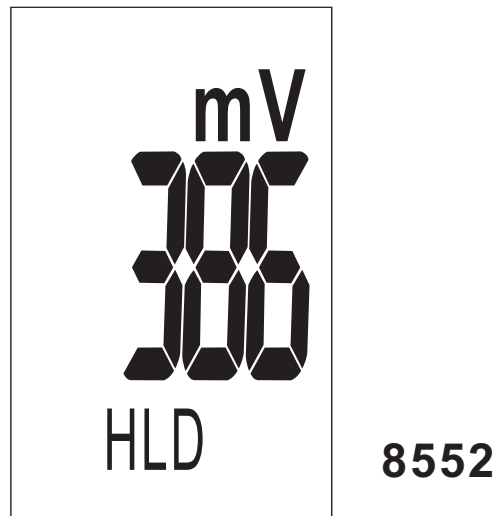

4. Press " " to freeze current readings.
The text "Hold" will appear on the LCD
. Press " " again to release the
hold mode.





5. Turn off the meter by pressing " " button.
6. Once finishing the measurement, clean the electrode, put back the cap, store the meter under the 0~50°C.

AUTO POWER OFF (SLEEP FUNCTION)

This meter will shut off automatically 20 minutes of inactivity. For operating longer time, you can disable the sleep mode.

To disable the auto power off:

Before power on, pressing " " + " " keys simultaneously until a "n" appeared on the screen and then release keys to return to normal mode.

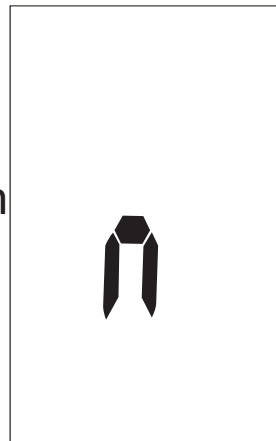

Note: The disable sleep mode will be invalid after every power off.

MAINTENANCE

Preparation:

Before using, remove the cover , then soak electrode into distilled water and rinse, and then take out and make dry. Now the electrode is ready for use.

NOTE:

Do not rub sensing element forcibly

Test the electrode:

- ✓ Put electrode in buffer solution of pH 7.00 with saturated quinhydrone. After stirring, mV reading(E1) should be 86 ± 15 mV.
- ✓ Rinse electrode with distilled water, then set it in buffer solution of pH4.01 with saturated quinhydrone. After stabilizing, record mV meter reading (E2). The difference between E1 and E2 should be 165mV.

Storage:

- ✓ Rinse the electrode with distilled water during the interval of each use.
- ✓ Keep ORP electrode wet. If not use for long period of time, it should be rinsed and stored in the provided soaking bottle which is filled with soaking solution.

ORP electrode cleaning:

If sensing element got contaminated, it will result in slow response and inaccurate reading. Clean it as following:

- ✓ If contamination is a mineral matter, put sensing element in HCL solution 0.1N for 10 minutes and then rinse it with distilled water.
- ✓ If the contamination is oil or grease coating, clean sensing element with detergent and rinse with distilled water.

TROUBLESHOOTING

◆ **Power on but no display**

- 1) Make sure the time of pressing power key is > 0.3 second.
- 2) Check the battery are in place and make good contact and correct polarity.
- 3) Replace with new batteries and try again.
- 4) Move away the batteries for one minute and then put back again.

◆ **Slow response**

Clean probe by immersing the electrode in tap water for 10-15 minutes, then rinse thoroughly with distilled water or use a general purpose electrode cleaner.

◆ **LCD display E02, E03**

Out of ORP measuring range.
Check in normal condition first, if remaining showing E02 or E03, the electrode is out of order.

SPECIFICATION

SPECIFICATIONS	8552
Accuracy \pm	4mV
Auto Power Off	●
Measurement range	-999 mV ~ +999mV
Resolution	1mV
Hold Data	●
Waterproof (IP65)	●
Size	165mm(L)x35mm(W)x32mm(T)

- ✓ Operating Temp.: 0°~60°C (32~140°F)
- ✓ Operating Humidity: 0~80% RH
- ✓ Battery Life: >200 hrs continuous use

WARRANTY

The meter is warranted to be free from defects in material and workmanship for a period of one year from the date of purchase. This warranty covers normal operation but does not cover battery, misuse, abuse, alteration, tampering, neglect, improper maintenance, or damage resulting from leaking batteries. Proof of purchase is required for warranty repairs . Warranty is void if the meter used to be taken apart.

RETURN AUTHORIZATION

Authorization must be obtained from the supplier before returning items for any reason. When requiring a RA (Return Authorization), please include data regarding the defective reason, the meters are to be returned along with good packing to prevent any damage in shipment and insured against possible damage or loss .

Accuracy, the Zenith of Measuring / Testing Instruments !

Hygrometer/Psychrometer

Thermometer

Anemometer

Sound Level Meter

Air Flow meter

Infrared Thermometer

K type Thermometer

K.J.T. type Thermometer

K.J.T.R.S.E. type Thermometer

pH Meter

Conductivity Meter

T.D.S. Meter

D.O. Meter

Saccharimeter

Manometer

Tacho Meter

Lux / Light Meter

Moisture Meter

Data logger

Temp./RH transmitter

Wireless Transmitter

More products available !

2014/06 Ver.1